

CHIRMED®

Nożyczki chirurgiczne
Surgical Scissors
Chirurgische Scheren
Хирургические ножницы

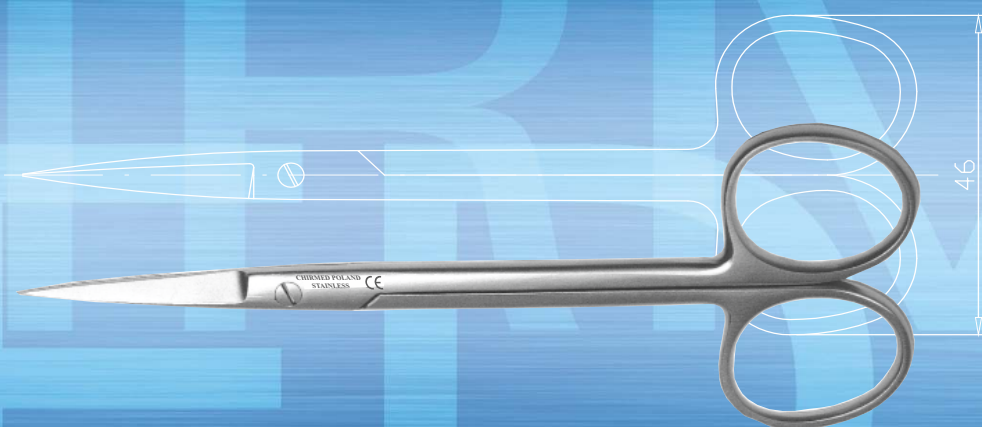

from IDEA to SOLUTION



IDENTYFIKACJA: (T/T) tępo/tępe (T/O) tępo/ostre (T/O) ostre/ostre
IDENTIFICATION: blunt/blunt blunt/pointed pointed/pointed
IDENTIFIKATION: stumpf/stumpf stumpf/spitz spitz/spitz
ИДЕНТИФИКАЦИЯ: тупой/тупой тупой/острый острый/острый



STANDARD

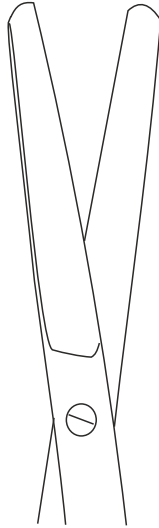

CO 212
130 mm (5 1/8")
(T/T)

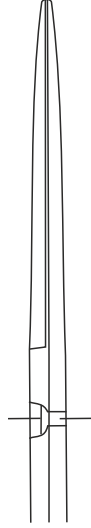

CO 213
130 mm (5 1/8")
(T/T)

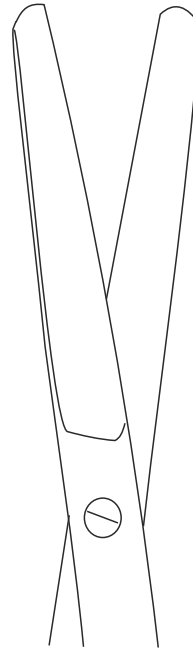
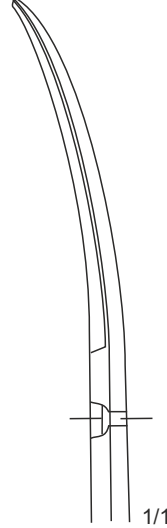

CO 89
165 mm (6 1/2")
(T/T)

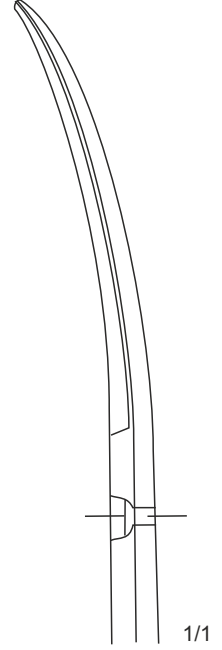
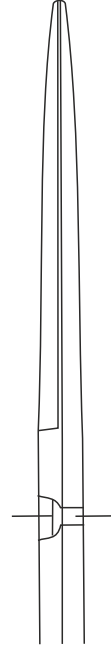

CO 211
165 mm (6 1/2")
(T/T)



STANDARD

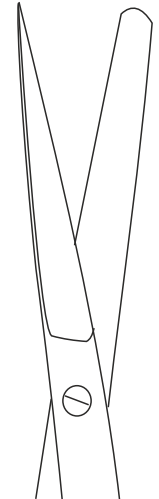

CO 215
130 mm (5 1/8")
(T/O)

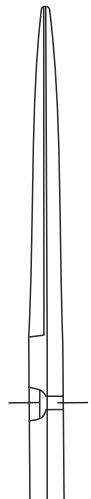

CO 216
130 mm (5 1/8")
(T/O)

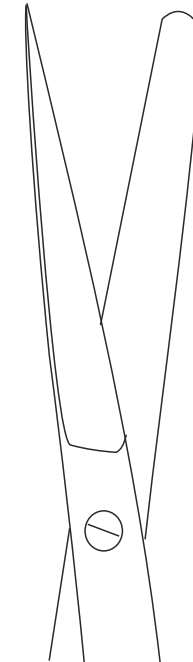
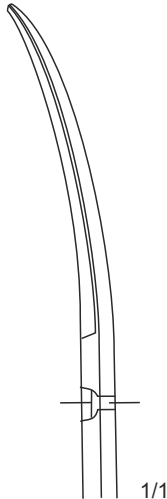

CO 90
165 mm (6 1/2")
(T/O)

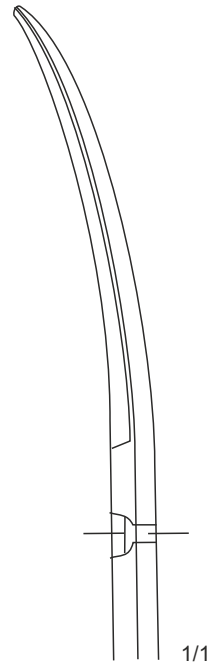
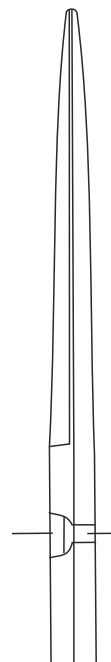

CO 214
165 mm (6 1/2")
(T/O)

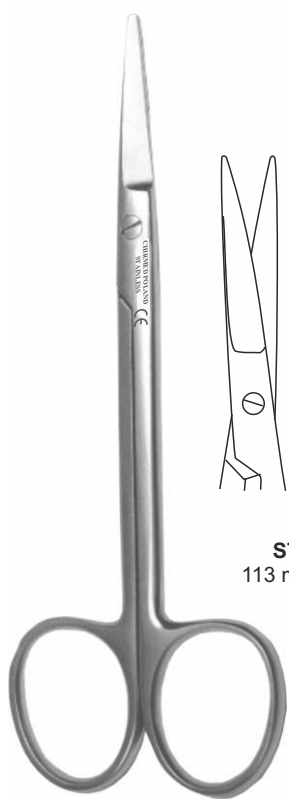

IRIS

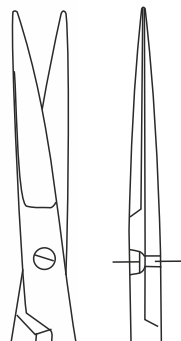

ST 2071
113 mm (4 3/8")
(T/T)

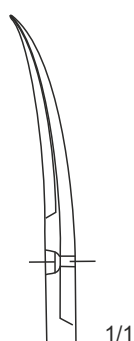

ST 2072
113 mm (4 3/8")
(T/T)

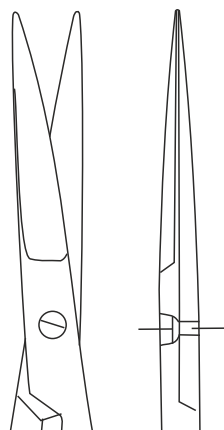

ST 2073
118 mm (4 3/4")
(T/T)

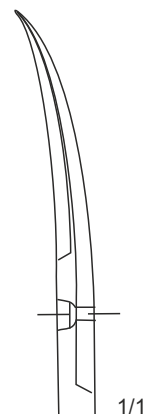

ST 2074
118 mm (4 3/4")
(T/T)

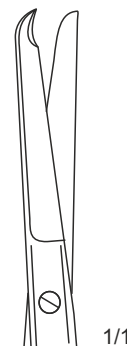

ST 2286
115 mm (4 1/2")

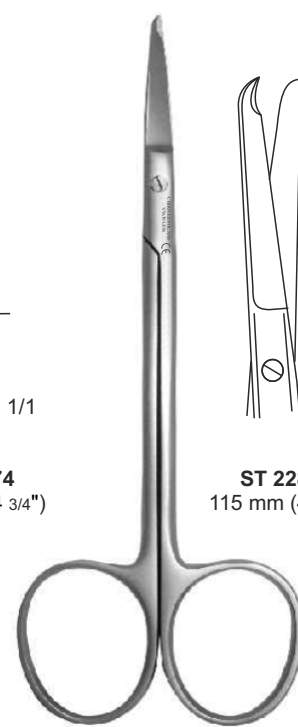

SPENCER



IRIS

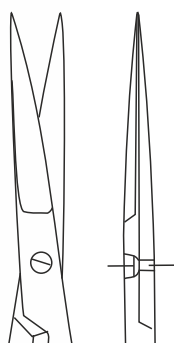

ST 2014
115 mm (4 3/8")
(O/O)

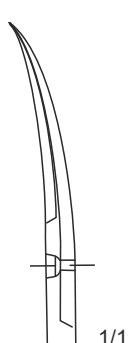

ST 2015
115 mm (4 3/8")
(O/O)

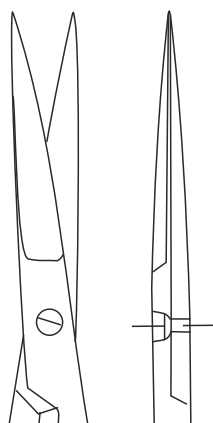

ST 2022
120 mm (4 3/4")
(O/O)

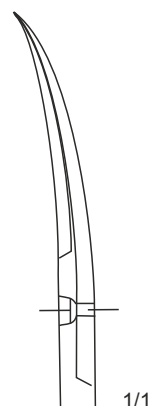

ST 2023
120 mm (4 3/4")
(O/O)

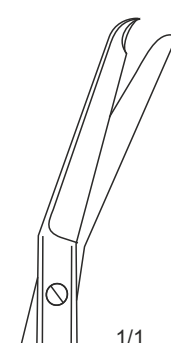

ST 2287
115 mm (4 1/2")

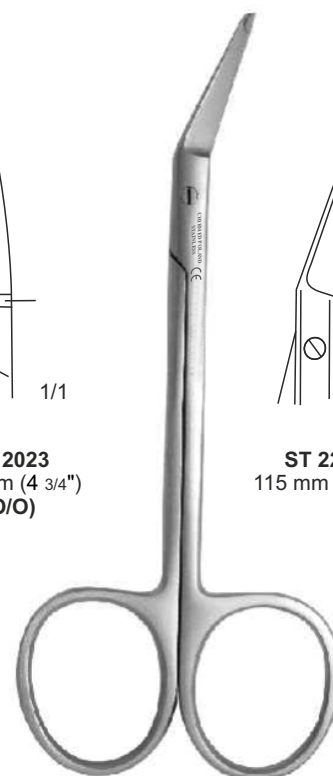

SPENCER

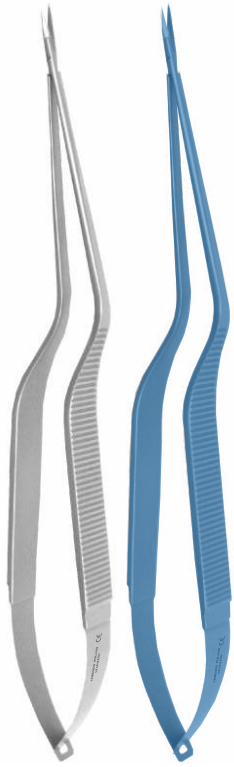

MK 210 **MK 210/T**
TITANIUM

Ostrze
Blade
Schneide
Край

Długość całkowita
Total Length (in)
Gesamtlänge
Общая длина

220 mm (8 3/4")
(O/O)

220 mm (8 3/4")
(O/O)

TITANIUM

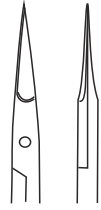

STANDARD

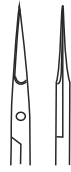

MK 212

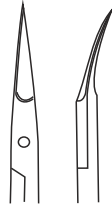

STANDARD

MK 211

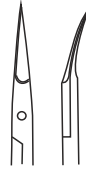

MK 213



STANDARD

MK 214

1/1

Ostrze
Blade
Schneide
Край

Długość całkowita
Total Length (in)
Gesamtlänge
Общая длина

160 mm (6 1/3")

160 mm (6 1/3")

TITANIUM

180 mm (7")

180 mm (7")

TITANIUM



MK 329



MK 320

MK 329/T

MK 320/T

MK 330/T

MK 321/T



MK 329 **MK 329/T**
160 mm (6 1/3")
TITANIUM

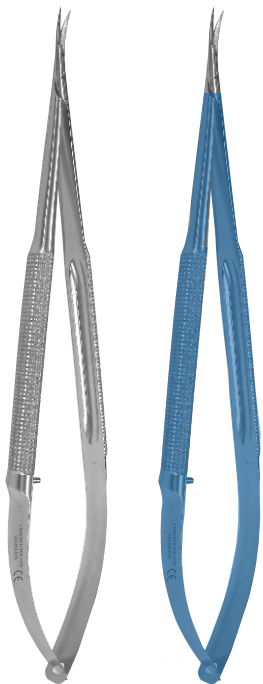

STREAMLINE
MK 316 **MK 316/T**
178 mm (7")
TITANIUM

Ostrze
Blade
Schneide
Край

Długość całkowita
Total Length (in)
Gesamtlänge
Общая длина

178 mm (7")

178 mm (7")

TITANIUM



MK 316



MK 317

MK 316/T

MK 317/T

Ostrze
Blade
Schneide
Край

Długość całkowita
Total Length (in)
Gesamtlänge
Общая длина

150 mm (6")

150 mm (6")

TITANIUM



MK 325



MK 326

MK 325/T

MK 326/T

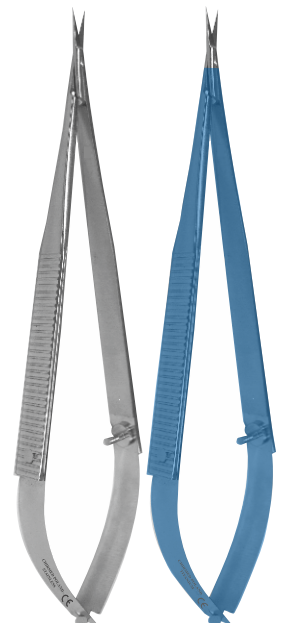

MK 326 **MK 326/T**
150 mm (6")
TITANIUM